

The intuitive Trustep foot is designed to provide a combination of the vertical motion, rotation and stability associated with the anatomical foot. Throughout the gait cycle, the bumpers compress to bring the toe and heel down at the appropriate times, allowing the foot to maintain ground contact for firm footing.

The unique split-keel design that defines the Trustep provides up to 15mm of independent toe dorsiflexion during normal use. With a full range of options available, Trustep's versatile design allows for complete customisation, resulting in a natural gait pattern and unsurpassed comfort.

CES CPI F03: Use this code to read the Trustep clinical evaluation summary on the Steeper website.

Features and Benefits

- Tri-axial technology to adapt to uneven terrain
- Bumpers compress the toe and heel at appropriate times whilst providing cushioning and impact absorption
- Customisable bumpers for optimal control
- Anatomically designed foot shell with Spectra reinforcement
- Trustep patented Sealing Boot interlocks with the foot shell, keeping debris away from the foot



10mm vertical displacement



Anatomical locomotion

Cosmetics



Sealing Boot



Solid toe foot shell

Note: Please see the following page for Trustep spare parts ordering information.



Ordering Information

Trial Period - This foot has a 30 day trial period.

Impact Level Descriptions

Low: Daily activities include mostly level ground walking, moving around the home and the community.

Moderate: Daily activities include up to unlimited walking, climbing stairs and occasional moderate lifting (this does not include running).

High: Daily activities include fast walking, jogging, running, lifting heavy objects and/or recreational sports.

Ordering Example: NTS-LCEN-24N-G3

| Part ID | Side | Shell Colour | Mounting | Size | Width | Firmness Category |
|---------|------|--------------|----------|------|-------|-------------------|
| NTS | L | | | | | G |
| NTS | R | | | | | G |

Includes foot shell, CPI Spectra Sock and sealing boot.

| | | | | | | | |
|-----------|---|------|-----|---------|----------------------|---|------------------------|
| Caucasian | C | Endo | EN | 22-31cm | Narrow | N | 1-9 See Chart Below |
| Tan | T | Exo | ALX | | Wide 24-31cm only | W | |
| Brown | B | | | | | | |
| Jet Black | J | | | | | | |

Firmness Category

| Weight (kg) | Sizes 22-31cm | | |
|-------------|---------------|------------|-------------|
| | Low Impact | Mod Impact | High Impact |
| 0-33 | 1 | 1 | 2 |
| 34-45 | 2 | 2 | 3 |
| 55-63 | 3 | 3 | 4 |
| 64-72 | 4 | 4 | 5 |
| 73-81 | 4 | 5 | 6 |
| 82-91 | 5 | 6 | 6 |
| 92-100 | 6 | 6 | 7 |
| 101-113 | 6 | 7 | 7 |
| 114-125 | 7 | 7 | 8 |
| 126-136 | 8 | 8 | 8 |
| 137-150 | 8* | 9* | 9* |
| 151-160 | 9* | 9* | 9* |

* EXO Only

Product Specification

| Mount | Weight Limit | Build Height | Sizes |
|---------------------------------|--------------|---|---|
| Endo (IP) | 136kg | 8.7cm | 22-31cm |
| Exo (ALX) | 160kg | 15.2cm | |
| Weight of Unit | Impact Level | Warranty | Foot Shell |
| 678g Size 26 inc. foot shell | L M H | 3 years (18 months over 136kg) Foot shell - 6 months | C T B J Caucasian, Tan, Brown or Jet Black Narrow or Wide width |

Technical Information

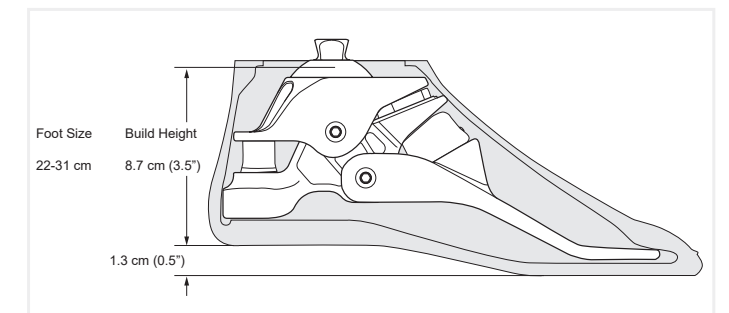

Spare Parts Ordering Information

| Foot Shell | Size (cm) | Shell |
|---------------|-----------|-------|
| NTS-S ■●●-▲● | 22-31 | S |
| NTS-XS ■●●-▲● | 22-31 | XS* |

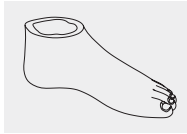

*Exo only, add 1 day for processing.

- = "L" or "R" for Left or Right
- = Colour (C = Caucasian, T = Tan, B = Brown, J = Jet Black)
- ▲ = Foot size in cm (22-31)
- ◆ = Width (N = Narrow, W = Wide*) *24-31cm only

| Shelltread | Size (cm) |
|--------------|-----------|
| NTS-T ■●●-▲N | 21-30 |
| NTS-T ■●●-▲W | 24-31 |



- = "L" or "R" for Left or Right
- = Colour (N = Neutral, J = Jet Black)
- ▲ = Foot size in cm (22-31)
N = Narrow, W = Wide

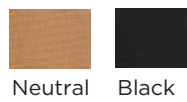

| CPI Spectra Sock | Size (cm) |
|------------------|----------------|
| NTS-SS-2231 | 22-31 |
| NTS-SSK-2231 | 22-31 (6 pack) |

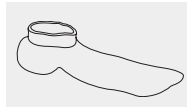

| Endo Sealing Boot | Size (cm) |
|-------------------|-----------|
| NTS-SB ■●●-2224 | 22-24 |
| NTS-SB ■●●-2526 | 25-26 |
| NTS-SB ■●●-2730 | 27-30 |

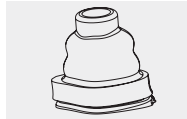

- = "L" or "R" for Left or Right
- = Colour (C = Caucasian, T = Tan, B = Brown, J = Jet Black)
- ▲ = Foot size in cm (25-30)

| Endo Ankle | Description |
|--------------|---------------------|
| NTS-ENA-2224 | Endo Ankle, 22-24cm |
| NTS-ENA-2531 | Endo Ankle, 25-31cm |

| Exo Ankle | Description |
|---------------|--------------------|
| NTS-ALXA-2224 | Exo Ankle, 22-24cm |
| NTS-ALXA-2531 | Exo Ankle, 25-31cm |

| Forefoot | Description |
|---------------|---------------------------------------|
| NTS-FF-2224 ■ | Forefoot Bone, 22-24cm |
| NTS-FF-▲■ | Forefoot Bone, indicate size: 25-30cm |
| NTS-FF-31 | Forefoot Bone, 31cm |

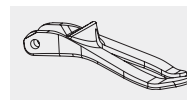

- = "L" or "R" for Left or Right
- ▲ = Foot size in cm (25-30)

| Gait Match | | | | | |
|-------------------|--------------|----------------|----------------|-------------|----------------|
| Firmness Category | Front Bumper | Ankle Bushings | Mid-stance Pad | Rear Bumper | Lower Bushings |
| 1 | 1 | S | M | XS | one firmness |
| 2 | 2 | S | M | XS | one firmness |
| 3 | 3 | S | M | S | one firmness |
| 4 | 4 | S | M | S | one firmness |
| 5 | 5 | M | M | M | one firmness |
| 6 | 6 | M | M | H | one firmness |
| 7 | 7 | M | M | 1X | one firmness |
| 8 | 8 | F | F | 2X | one firmness |
| 9 | 8 | F | F | 3X | one firmness |

Foot orders include extra rear bumper (one category softer, recommended for AK)

| Bumpers & Bushings | Description | Bumper Colour |
|--------------------|-----------------------|---------------|
| NTS-FB-1 | Front Bumper 1 | - |
| NTS-FB-2 | Front Bumper 2 | - |
| NTS-FB-3 | Front Bumper 3 | - |
| NTS-FB-4 | Front Bumper 4 | - |
| NTS-FB-5 | Front Bumper 5 | - |
| NTS-FB-6 | Front Bumper 6 | - |
| NTS-FB-7 | Front Bumper 7 | - |
| NTS-FB-8 | Front Bumper 8 | - |
| NTS-FB-9 | Front Bumper 9 | - |
| NTS-RB-XS | Rear Bumper, XS | - |
| NTS-RB-S | Rear Bumper, S | - |
| NTS-RB-M | Rear Bumper, M | - |
| NTS-RB-H | Rear Bumper, H | - |
| NTS-RB-1X | Rear Bumper, 1X | - |
| NTS-RB-2X | Rear Bumper, 2X | - |
| NTS-RB-3X | Rear Bumper, 3X | - |
| NTS-MP-M | Midstance Pad, Medium | M |
| NTS-MP-F | Midstance Pad, Firm | F |
| NTS-LB | Lower Bushing | - |
| NTS-ABS | Ankle Bushing, Soft | S |
| NTS-ABM | Ankle Bushing, Medium | M |
| NTS-ABF | Ankle Bushing, Firm | F |
| NTS-ABR | Ankle Bushing, Rigid | - |

S Soft M Medium F Firm XF Extra Firm

| Alignable Exo Block | Description |
|---------------------|----------------------------------|
| NTS-XBK ■-2224 | Alignable Exo Block Kit, 22-24cm |
| NTS-XBK ■-2526 | Alignable Exo Block Kit, 25-26cm |
| NTS-XBK ■-2731 | Alignable Exo Block Kit, 27-31cm |



- = "L" or "R" for Left or Right
- Includes Exo Block, Lamination Gasket and Mounting Bolt.

| Moulded Heel Bone | Description |
|-------------------|----------------------------------|
| NTS-MH-2224 | Moulded Heel Bone, 22-24cm |
| NTS-MH-2526 | Moulded Heel Bone, 25-26cm |
| NTS-MH-2731 | Moulded Heel Bone, 27-31cm |
| NTS-MHK-2224 | Moulded Heel Bone Kit, 22-24cm** |
| NTS-MHK-2526 | Moulded Heel Bone Kit, 25-26cm** |
| NTS-MHK-2731 | Moulded Heel Bone Kit, 27-31cm** |



- **Moulded Heel Bone Kit Contents:
- 1 x NTS-MAX-MH (Trustep MAX insert)
 - 1 x NTS-IS-MH (Trustep Max/Min insert screw)
 - 1 x NTS-MH-2224/2526/or 2731 (Trustep Moulded Heel Bone)

| Exo Pyramid Tool Kit | Description |
|----------------------|----------------------------|
| NTS-EXPK-30 | Exo Pyramid Tool Kit, 30mm |

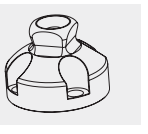

| Hardware | Description |
|------------|--|
| NCP-AP-L | Axial Pin, Long, 22-31cm |
| NCP-APS | Axial Pin Screw |
| NTS-MAX-MH | Max Insert, Moulded Heel |
| NTS-MIN-MH | Min Insert, Moulded Heel |
| NTS-IS-MH | Max/Min Insert Screw, Moulded Heel |
| NTS-S10-25 | Exo Mounting Bolt, M10 x 25mm |
| NTS-RBK | Pyramid Tool Retaining Bolt Kit (4pc), M6 x 12mm |

