

The Venture foot has a full-length toe lever for a more dynamic response for active users.

Its two-stage response enables the dorsiflexion bumper to compress providing comfort during walking; this compression is controlled to engage the composite keel which improves the foot's response to high-impact activities. The heel bumper can be fine-tuned to achieve the ideal heel strike compression.

Designed for a demanding lifestyle, whether being used in the gym or the office, the precise engineering of the Venture generates a dynamic performance without sacrificing comfort.

Features and Benefits

- Tri-axial technology easily adapts to any terrain
- Energy storing to reduce fatigue
- Adjustable Stride Control™ - using 4mm hex key to customise the user's gait timing, even with the foot shell on
- Smooth transition from high to low activities



Cosmetics

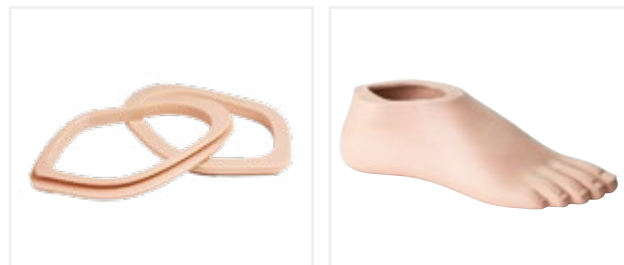

Note: Please see the following page for Venture spare parts ordering information.



Ordering Information

Trial Period - This foot has a 30 day trial period.

Impact Level Descriptions

Low: Daily activities include mostly level ground walking, moving around the home and the community.

Moderate: Daily activities include up to unlimited walking, climbing stairs and occasional moderate lifting (this does not include running).

High: Daily activities include fast walking, jogging, running, lifting heavy objects and/or recreational sports.

Ordering Example: NV-LCEN-24W-G4

Part ID	Side	Shell Colour	Mounting	Size	Width*	Firmness Category
NV	L					G
NV	R					G

Includes foot shell, CPI Spectra Sock and cosmetic attachment plate.	Caucasian C	Endo EN	21-30cm	Narrow N	1-5
	Tan T	Exo ALX		Wide *24-30cm only W	
	Brown B				
	Jet Black J				

Firmness Category	Weight (kg)	0-45	46-54	55-63	64-72	73-81	82-91	92-100	101-113	114-125
Size (cm)		21-24								
Low Impact		1	1	2	3	3	4	4	5	-
Moderate Impact		1	2	3	3	4	4	5	5	-
High Impact		2	3	3	3	4	4	5	5	-
Size (cm)		25-30								
Low Impact		1	1	2	3	3	4	4	5	5
Moderate Impact		1	2	3	3	4	4	5	5	-
High Impact		2	3	3	4	4	4	5	5	-

Product Specification

Mounting	Build Height	Weight Limit	Impact Level
Endo (IP)	6.4-6.9cm	113kg (Sizes 21-24cm)	LMH
Exo (ALX)	12.7-13.2cm	125kg (Sizes 25-30cm)	
Weight of Unit	Sizes (cm)	Warranty	Foot Shell
585g Size 26 inc. foot shell	21-30cm	3 years Foot shell - 6 months	C T B J Caucasian, Tan, Brown or Jet Black Narrow or Wide width

Technical Information

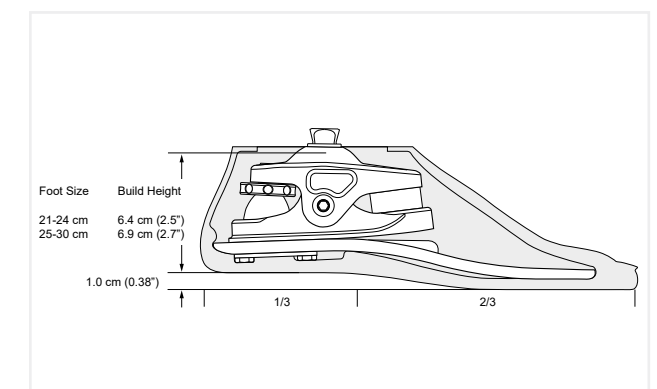

Spare Parts Ordering Information

Foot Shell	Size (cm)
NV-S ■●-▲N	21-30
NV-S ■●-▲W	24-30



CAP	Size (cm)
NV-C ■●-2124	21-24
NV-C ■●-2526	25-26
NV-C ■●-2730	27-30



■ = "L" or "R" for Left or Right  
 ● = Colour (C = Caucasian, T = Tan, B = Brown, J = Jet Black)  
 ▲ = Foot size in cm (21-30)  
 N = Narrow, W = Wide

Shelltread	Size (cm)
NV-T ■●-▲N	21-30
NV-T ■●-▲W	24-30



■ = "L" or "R" for Left or Right  
 ● = Colour (N = Neutral, J = Jet Black)  
 ▲ = Foot size in cm (21-30)  
 N = Narrow, W = Wide

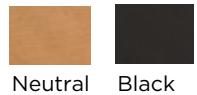

CPI Spectra Sock	Size (cm)
NCPI-SS-SM	Small (19-25cm)
NCPI-SS-LG	Large (26-31cm)
NCPI-SSK-SM	Small 6 pack (19-25cm)
NCPI-SSK-LG	Large 6 pack (26-31cm)

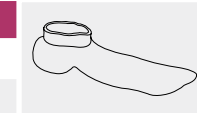

Foreheel	Description
NV-FHA ■-▲-◆	Foreheel

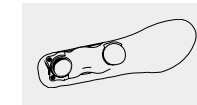

■ = "L" or "R" for Left or Right  
 ▲ = Foot size in cm (21-30)  
 ◆ = Firmness (M = Medium, X = Extra Firm)

Bumpers & Bushings	Description	Bumper Colour
NV-FBS-●	Front Bumper, Soft	S
NV-FBM-●	Front Bumper, Medium	M
NV-FBF-●	Front Bumper, Firm	F
NV-FBX-A	Front Bumper, Extra Firm, 27-30cm	XF
NV-RBS-▲	Rear Bumper, Soft	S
NV-RBM-▲	Rear Bumper, Medium	M
NV-RBF-▲	Rear Bumper, Firm	F
NV-RBX-▲	Rear Bumper, Extra Firm	XF
NTS-ABS	Ankle Bushing, Soft, 21-30cm	S
NTS-ABM	Ankle Bushing, Medium, 21-30cm	M
NTS-ABF	Ankle Bushing, Firm, 21-30cm	F
NV-ABS-2530	Ankle Bushing, Soft, 25-30cm	S
NV-ABM-2530	Ankle Bushing, Medium, 25-30cm	M
NV-ABF-2530	Ankle Bushing, Firm, 25-30cm	F
NV-BK-2130	Bumper Kit	

S Soft M Medium F Firm XF Extra Firm  
 ● = Front Bumper (FB) ▲ = Rear Bumper (RB)

Pocket Size	Foot Size		
	21-24cm	25-26cm	27-30cm
● (FB)	C	B	A
▲ (RB)	D	C	B

Exo Ankle	Description
NV-ALXA-2124	Exo Ankle, 21-24cm
NV-ALXA-2530	Exo Ankle, 25-30cm

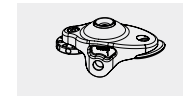

Endo Ankle	Description
NV-ENA-2124	Endo Ankle, 21-24cm
NV-ENA-2530	Endo Ankle, 25-30cm

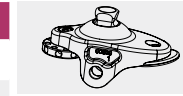

Growth Plate Kit	Description
NV-GPK-7	Growth Plate Kit, 7mm
NV-GPK-14	Growth Plate Kit, 14mm
NV-GPK-21	Growth Plate Kit, 21mm
NV-GPK-28	Growth Plate Kit, 28mm

Exo Pyramid Tool Kit	Description
NTS-EXPK-30	Exo Pyramid Tool Kit, 30mm

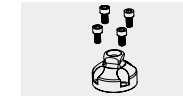

Exo Block Kit	Description
NV-XBK-2124	Alignable Exo Block Kit, 21-24cm
NV-XBK-2526	Alignable Exo Block Kit, 25-26cm
NV-XBK-2730	Alignable Exo Block Kit, 27-30cm



Includes Mounting Bolt

Hardware	Description
NCP-AP-SH	Axial Pin, Short, 22-24cm
NCP-AP-L	Axial Pin, Long, 25-30cm
NCP-APS	Axial Pin Screw
NTS-S10-25	Exo Mounting Bolt, M10 x 25mm
NV-B10-35	Exo Mounting Bolt, M10 x 35mm
NV-B10-45	Exo Mounting Bolt, M10 x 45mm
NTS-RBK	Pyramid Tool Retaining Bolt Kit (4pc), M6 x 14mm

